

# The Pittsburgh Conference on Analytical Chemistry and Applied Spectroscopy

(a Pennsylvania non-profit Corporation)

## Display Rules and Regulations



**Pennsylvania Convention Center  
Philadelphia, Pennsylvania**

**March 17 – March 21, 2019**

Exposition Dates: Tues., March 19 – Thurs., March 21, 2019

9:00 AM – 5:00 PM

**THE PITTSBURGH CONFERENCE  
300 Penn Center Blvd., Suite 332  
Pittsburgh, PA 15235-5503**

**Phone: (412) 825-3220**

**Toll Free: (800) 825-3221**

**FAX: (412) 825-3224**

**E-Mail: [expo@pittcon.org](mailto:expo@pittcon.org)**

## Important Dates and Deadlines for Pittcon 2019

- Last day for incentive rate on Electrical, Air &

### MAY 2018:

- Thurs., May 17 – 2:00 PM – 3:00 PM
  - Exhibitor's webinar

### JUNE 2018:

- Mon., June 4, 2018
  - Booth Space signups begin on-line

### AUGUST 2018:

- Mon., August 6, 2018
  - Booth assignments begin in seniority order for companies 800 sq. ft. or more (booth + seminar room space)
- Mon., August 13, 2018
  - Booth assignments begin in seniority order for any companies under 800 sq. ft.

### OCTOBER 2018:

- Fri., October 12, 2018
  - Last day for 75% refund on cancellation of booth space
- Wed., October 31, 2018
  - Booth assignments emailed to exhibitors

### NOVEMBER 2018:

- Fri., November 2, 2018
  - Exhibitor Service Manual available on-line
- Fri., November 16, 2018
  - Last day for 50% refund on cancellation of booth space
- Mon., November 19, 2018
  - Balance of booth space payments due

### JANUARY 2019:

- Mon., January 7, 2019
  - Last day for 25% refund on cancellation of booth space
- Mon., January 21, 2019
  - Exhibitor Appointed Contractor form due
  - Hanging banner, specialized lighting and exhibit drawings are due to The Pittsburgh Conference for approval
  - Certificate of Insurance or Signed Waiver & Release due to The Pittsburgh Conference

### FEBRUARY 2019:

- Fri., Feb 8, 2019
  - First day that items can be received at the Global Experience Specialists – (GES) Advance Warehouse
- Thurs., February 21, 2019
  - GES advance discount pricing deadline

Water Services provided by Pennsylvania Convention Center

- Last day for incentive rate on Internet & Telephone Services provided by Pennsylvania Convention Center

### MARCH 2019:

- Thurs., March 7, 2019
  - Last day that items can be received at the GES Advance Warehouse
- Wed., March 13, 2019
  - GES standard pricing deadline
- Thurs., March 14, 2019
  - Exhibitor move-in begins
  - First day items can be received at the Pennsylvania Convention Center
  - GES on-site pricing begins
- Fri., March 15, 2019
  - Exhibitor Registration opens – badge pick up only
- Sat., March 16, 2019
  - Short Courses open
- Mon., March 18, 2019
  - Technical Program opens
  - Seminar Rooms accessible for exhibitor-to-exhibitor use only
  - Booths to be carpeted by 5PM
- Tues., March 19, 2019
  - Booths to be fully assembled by 8AM
  - Exhibits Open to all attendees
  - Seminar Rooms accessible to all attendees by 9AM
- Thurs., March 21, 2019
  - Exhibitor's Meeting – 11:30 AM-1:00 PM
  - Exposition closes – 5:00 PM
  - Move Out starts at 5:01 PM
- Thurs., March 21 – Sat., March 23, 2019
  - Move Out continues

## Benefits to Exhibitors at Pittcon 2019:

- Exhibit Floor Space:
  - 24 hour Exhibit Floor Perimeter Security
  - Aisle Carpet – blue jay
  - Nightly vacuuming of aisles
  - Booth number on floor for space identification
  - 8' Back Drape in exposition color- black
  - Two (2) 3' Side Rails Draped in black
  - 11" x 17" booth identification sign with your company name and booth number
- Company description posted online and on Mobile App.
- Opportunity to rent advance registration list of attendees.
- Exclusive exhibitor promotional and advertising opportunities. Email [marketing@pittcon.org](mailto:marketing@pittcon.org) for more information.
- Opportunity to rent Seminar Rooms on the exposition floor.
- Opportunity to rent meeting space on the exposition floor.
- On-line Exhibitor Service Manual
- Eight (8) Complimentary Registrations for every 10' x 10' purchased – provide full access to the exhibit floor and technical program
  - Four (4) for Booth Personnel
  - Four (4) for Corporate Guests
- Additional Corporate Guest Registrations available at discounted price.
- Complimentary Items (includes official souvenir, Final Program, apples)
- Regular issues of Expo e-newsletter.
- Access to the online Exhibitor Success & ROI Center (includes exhibiting tools, webinars, and more)
- Complimentary press conference facilities.
- Distribute press kits in the Publicity Office.
- Downloadable logos and marketing tools.
- Discounted hotel room rates.
- Complimentary shuttles from hotels in room block to convention center.
- Complimentary Internet Cafe available on exposition floor.
- Complimentary Exhibitor Lounges available on the exposition floor.
- Complimentary Wi-Fi available on the exposition floor ('5 GHz WiFi'), adequate for emails and surfing, not for presentations.

To ensure a smooth and uneventful move-in, set-up and exposition, please contact Pittcon Exposition Management if you have any questions after reviewing these Pittcon 2019 Display Rules.

Exposition Manager: Tammy Yallum [yallum@pittcon.org](mailto:yallum@pittcon.org) (412) 825-3220 ext. 205  
Exposition Chairman: Geoff White [white@pittcon.org](mailto:white@pittcon.org) (412) 600-9109 (Cell)

**Abbreviations:** PEM – Pittcon Exposition Management, GES – Global Experience Specialist, BSA – Booth Space Agreement –(the online contract found on the exhibitor dashboard only), PCC – Pennsylvania Convention Center, EAC – Exhibitor Appointed Contractor

*Those unfamiliar with the various types of booth layouts may wish to review pages 10 through 14 of this document before reading through the sections below.*

## Pittcon 2019 Changes in Display Rules & Regulations (Rev. 5/2018)

- **Height Restriction on All In-Line Booths:** The maximum height limit on all in-line booths, including cross-aisle booths, is 8' 3". This change was introduced four years ago to bring Pittcon in alignment with the International Association of Exhibitions and Events™ (IAEE) *Guidelines for Display Rules and Regulations* which is considered the industry standard for North American expositions.
- **Height Restriction Area):** The maximum height limit on all booths placed in Hall A is 8'3" and Hanging Banners are not permitted in this area.
- **Banner Restrictions:** The maximum height for hanging banners in PCC is 24' from the floor. In cross-aisle booths, banners that span the aisle may not be less than 15' from the floor.
- **Peninsula / Island Booths:** Detailed plans for **ALL** peninsula and **ALL** island configurations **MUST** be submitted to PEM for approval. The deadline for submission of such plans is Monday, January 21, 2019. **Solid walls in an island configuration are prohibited. A sufficient "see-through or walk-through" area, 5' from each end of any displays, must be maintained so as not to block the view of adjacent booths.**
- **Floor Covering:** Bare floors are prohibited in display areas and therefor floor covering in exhibit spaces must be installed by 5:00 PM on Monday, March 18, 2019. If floors are not covered by this time PEM will direct that the floor be covered and the cost will be invoiced to the exhibitor. PEM reserves the right to determine if contents of any exhibitor space, including floor covering constitutes a hazard to the show. Failure to correct such hazard reserves the right of removal from show floor. Plastic, vinyl, and fabric that is less than ¼ inch in thickness and/or not sufficiently adhered to the floor are some examples of hazardous floor covering material and are not permitted to be used. Floor covering must cover the entire booth space.

## General Information and Requirements

- **No Show Policy:** Any booth that is not occupied by 8:00 AM on Tuesday, March 19, 2019 will be regarded as a "no-show" and will therefor receive no refund. All freight will be removed from such a booth and returned to the loading dock and the cost will be invoiced to the exhibitor. **An unmanned booth is a "no-show" and will result in a 20% reduction of seniority.**
- **Children on the Expo Floor:**
  - **During Move-In / Set-Up and Move-Out / Tear Down** – no one under the age of 16 is permitted on the exposition floor.
  - **During Show Hours** – children under the age of 16 must register in the Registration area in order to be admitted to the exposition floor and must be accompanied by a registered adult at all times. **No strollers, backpacks, carriages, or similar devices for transporting children are permitted at any time. Exposition features are not intended for use by children; registered accompanying adults must prevent children from disrupting the experience of other attendees.**
- **Insurance:**
  - Each Exhibitor shall provide PEM with a certificate of insurance evidencing that, during the setup and exhibition dates of Pittcon 2019, Exhibitor will have in full force and effect a comprehensive general liability insurance policy also containing contractual liability insurance and covering claims of bodily injury, death and property liability arising out of Exhibitor's operations, assumed liability for use of Space and Convention Center, with a combined single limit of at least \$1,000,000.00. Exhibitor's insurance must provide that it is primary coverage for all risks. **On the certificate please be certain that the company name under which you are exhibiting is specifically stated.** This will assist us in the event that your insurance is carried

under the name of a parent company. **PEM highly recommends that Exhibitors make every effort to obtain the general liability insurance.**

- If the Exhibitor is unable to provide a certificate to prove adequate insurance as identified above, the Exhibitor must sign and return the "WAIVER AND RELEASE". By signing the waiver, the exhibitor assumes all responsibility and releases The Pittsburgh Conference from all claims arising from the Exhibitor's participation in Pittcon 2019.
- Exhibitors who experience difficulty obtaining insurance coverage at a reasonable cost, may contact Kendra Reilly - John Buttine Inc., 420 Lexington Avenue, Suite 2700, New York, NY 10170, Phone:(212) 867-3642, Fax: (212) 504-8084, E-mail: [kar@buttine.com](mailto:kar@buttine.com). John Buttine, Inc - New York is not related in any way to the Pittsburgh Conference or to any members of the Conference Committee. Also, neither the Pittsburgh Conference nor any member of the Conference receives any remuneration or any other consideration from John Buttine, Inc - New York or any of their agents.
- **ALL EXHIBITORS MUST, NO LATER THAN Monday, January 21, 2019, UPLOAD to their dashboard A CERTIFICATE OF INSURANCE SHOWING ABOVE COVERAGE (OR SIGNED WAIVER AND RELEASE). A COPY MAY ALSO BE SENT TO:**
  - Diane Kenna**  
**c/o The Pittsburgh Conference**  
**300 Penn Center Boulevard, Suite 332**  
**Pittsburgh, PA 15235-5503**  
**[kenna@pittcon.org](mailto:kenna@pittcon.org) or Fax: 412-825-3224**
- Exhibitors will not be permitted to use the space unless a certificate of insurance or signed waiver and release has been delivered to The Pittsburgh Conference. Contractors will not be permitted to operate in the PCC unless a certificate of insurance has been delivered to PEM.
- **Booth Height Restrictions:** Booth height is restricted to 8' 3" on all in-line booths including cross-aisle booths. Only island or peninsula booths may exceed this 8' 3" limit and such island or peninsula booths are restricted to a maximum height of 20'.
- **Overhead Lighting:** Overhead lighting and lighting trusses require approval by PEM. All submissions for approvals must be received by Monday, January 21, 2019. Exhibitors shall adhere to the following rules:
  - Lighting must be directed to the inner confines of the booth space and shall not project onto other exhibits or exposition aisles.
  - Any lighting truss must be offset from the boundaries of the booth by at least 5' (1.5 m) on all sides.
  - The costs for rigging and wiring are the exhibitor's responsibility.
- **Specialized Lighting:** Specialized lighting requires approval by PEM and is subject to onsite inspection prior to use at Pittcon 2019. All submissions for approvals must be received by Monday, January 21, 2019. Lighting that spins, rotates or pulsates, and other specialized lighting effects shall not interfere with neighboring exhibitors or otherwise detract from the general atmosphere of the event. Strobe lights are prohibited.
- **Hanging Banners:** Hanging banners are **ONLY permitted** over island, peninsula, and cross-aisle booths and seminar rooms. **Hanging Banners require approval by PEM.** The banner request (must include detailed drawings) and banner payment deadline is Monday, January 21, 2019. Only those exhibitors whose requests have been approved will be allowed to schedule rigging services.
  - In the PCC, the top of the hanging banner can be a maximum of 24' above the floor. There is no height limit for the bottom of the banner, unless placed over a cross aisle. The bottom of a banner that spans a cross-aisle must not be less than 15' above the floor.
  - Banners for in-line configurations are permitted as long as such banners are suspended from the booth structure and do not exceed the 8' 3" height restriction for the booth. **These banners may not be suspended from the ceiling.**
  - The costs and production of any banners, as well as any rigging, are the exhibitor's responsibility.
- **Peninsula Booths** are contiguous blocks of space purchased by an exhibiting company that have a total area of at least 400 square feet with aisles on three sides.
  - Within Peninsula Booths, full use of the floor space to the **maximum height for the area (20')** is permitted **only if objects over 4' in height are set back 5' from any aisle and 9' from any neighboring exhibit.** These set back distances ensure sufficient "see-through or walk-through" space is provided so as not to block the view of adjacent exhibits.
  - Detailed plans for **ALL** peninsula configurations **MUST** be submitted to PEM for approval. The deadline for submission of such plans is Monday January 21, 2019.
  - Additional information on peninsula booths can be found on page 13.

- **Island Booths** are contiguous blocks of space that have a total area of at least 1,500 square feet with aisles on four sides and at least one interior cross aisle. An Island Booth may also have one or more 10' x 10' double-decker booths.
  - Within Island Booths, full use of the floor space to the **maximum height for the area (20')** is permitted. **However, sufficient “see-through or walk-through” area must be provided so as not to block the view of adjacent exhibits.**
  - PEM **MUST** be notified of any **solid structure on any side** such as a wall or built-in storage prior to booth space assignment.
  - Detailed plans for **ALL** island configurations **MUST** be submitted to PEM for approval. The deadline for submission of such plans is Monday January 21, 2019.
  - Additional information on island booths can be found on page 14.
- **Booth Appearance:** The rules below apply to all areas next to adjoining booths or areas visible from the aisles.
  - Bare floors are prohibited in display areas and therefore floor covering in exhibit spaces must be installed by 5:00 PM on Monday, March 18, 2019. If floors are not covered by this time PEM will direct that the floor be covered and the cost will be invoiced to the exhibitor.
  - Any portion of the exhibit bordering another Exhibitor's booth must have the back side of that portion finished and must not carry any identification signs or other copy that would detract from the adjoining exhibit. **Text and graphics must face into the booth and the back of any sign that exceeds 8' 3" (Island and Peninsula booths only) must be finished. No part of the graphic can be visible from the back of the booth. This includes any see-through panels where text / graphics are visible from the back side.**
  - Exposed, unfinished backgrounds that exceed 8' 3" in height (peninsula and island booths only) must be draped to present an attractive appearance as determined by PEM. If such draping is not ordered by the Exhibitor, GES, with the approval of PEM, will install it and the cost will be invoiced to the Exhibitor.
  - **If you are assigned a linear booth on a corner, you must bear the cost to drape any area next to the aisle which shows the back of your booth space.**
- **Booth Identification and Equipment:** No exhibitor identification signs or materials will be permitted outside the Exhibitor's booth area with the exception of approved Pittcon Promotional Opportunities.
- **Displays on Seminar Rooms:** Exhibitors may display company and product related signage and information on the outside of seminar rooms. However, the information cannot distract from the appearance of that or nearby seminar rooms or cause a disruption in the area. Exhibiting outside of the seminar rooms (e.g., hailing potential customers, stopping passers-by) is forbidden.
- **Canopies are only allowed in Peninsula and Island booths:**
  - Canopies or false ceilings may be used only in Peninsula and Island displays and are limited to a maximum height of 20'.
  - Canopies may not overhang the aisles in any configuration.
  - Identification signs and other copy are not permitted on the back and/or sides of extended height canopies which are within 9' of and face an adjoining exhibit.
  - Booth appearance rules apply to canopies.
- **Towers:**
  - Towers may be used in displays but are limited to a maximum height of 8' 3" for all in-line and cross-aisle booths and are limited to a maximum height of 20' for Peninsula and Island booths.
  - Any towers over 4' in height must be set back 5' from any aisle and 9' from any neighboring exhibit.
  - **Identification signs and other copy are not permitted on the back and/or sides of extended height towers which are within 9' of and face an adjoining exhibit.**
  - Booth appearance rules apply to towers.
- **Raised Floors:**
  - Raised floors or platforms are permitted as long as the combined height of the platform, display material, equipment and people standing on the platform conforms to the height restriction of the booth configuration.
  - Raised floors over 1' (0.30 m) in height will require a safety railing and drawings must be available for inspection by PEM, GES and PCC officials during erection, use, and dismantling of the platform.
  - The drawings must include the signature or stamp of a structural engineer.
  - All raised floors must meet local and federal legal requirements, for example, having necessary accessibility required by the ADA.

- **Clearances:**
  - Exhibitors must allow sufficient space for electrical, plumbing and other connections in the rear of their allotted 10' x 10' spaces. Exhibit structures must be limited to 10' x 9.5' to allow sufficient clearances at the rear of the booth for such services.
  - The Exhibitor shall restrict their exhibit to the established boundaries of their booth(s).
  - Unless otherwise stated, all aisles are 10' wide with 9' wide aisle carpet.
- **Display Installation:** The following rules apply to all display installation activities.
  - Display installation in the Pennsylvania Convention Center (PCC) will be permitted beginning Thursday, March 14, 2019. Installation must be completed by Tuesday, March 19, 2019 at 8:00 AM.
  - No labor will be available on Sunday, March 17, 2019 unless prearranged.
  - All crates and large boxes must be out of the aisle and contained in your space by 12:00 Noon, Monday, March 18, 2019. Any boxes or crates left in aisles and not unpacked at this time will be placed within the booth space.
  - No exhibitor is allowed to transport or install exposition equipment during exhibit hours without the approval of PEM.
  - The Pittsburgh Conference is not responsible for any loss or damage to Exhibitor's crates, boxes, and/or shipping material.
- **Shipping Instructions:** Direct shipments to the Pennsylvania Convention Center should not be scheduled to arrive before 8:00 AM on Thursday, March 14, 2019. Shipments to arrive **earlier** than 8:00 AM on Thursday, March 14, 2019 should be shipped to the GES Advance Warehouse – see the shipping section of the exhibitor's on-line service manual for addresses.
- **Exposition Hours:**
  - ***During Move-In / Set-Up and Move-Out / Tear-Down*** – all properly badged exhibitor personnel will have access to the Exposition Area. On Monday, March 18, 2019 Exhibitors may stay to work as late as needed provided they remain in the Exposition Area; **however, there may be limited or no reentry after hours if exhibitor personnel leave the Exposition Area.**
  - ***On Show Days*** – the Exposition will be open to all properly badged attendees as followings:
    - Tuesday, March 19, 2019 to Thursday, March 21, 2019 from 9:00 AM to 5:00 PM. The dates and times are subject to change on notice.
    - Exhibitors will be given access to the Exposition Area from 7:00 AM until 7:00 PM each day.
    - Exhibitor admittance to the Exposition Area at times other than those listed above will be by pass only and will require an accompanying security guard; the cost of said guard will be paid by the exhibiting company.
- **Housekeeping:** General maintenance of an exhibit is the sole responsibility of that Exhibitor.
  - Pressure sensitive tape(s) may **not** be used on painted surfaces.
  - All carpet tape must be removed from the hall floor and residue scraped by the Exhibitor or EAC prior to the end of the last day of move-out. Any tape or residue left by the Exhibitor or their EAC will be removed by GES beginning Saturday, March 23, 2019, and the Exhibitor will be invoiced for that service at the published overtime hourly rate.
  - Floors must be protected against dripping oil or other substances. If the premises are damaged in any way by act of negligence on the part of any Exhibitor, its agents, servants, or guests, the Exhibitor will pay restitution for such damages to the PCC.
  - Exhibitors with cross-aisle booths are responsible for cleaning any exhibitor owned or rented carpet that occupies the aisle space.
- **Music, Photographs and Other Copyrighted Materials:** Each Exhibitor is responsible for obtaining all necessary licenses and permits to use music, photographs or other copyrighted material in Exhibitor's booth or display. This provision shall not be deemed a waiver or modification of Paragraph 14 of the Terms and Conditions of the 2019 BSA and Exhibitor shall remain liable for and shall indemnify and hold the Conference and the Authority, their agents and employees, harmless from all loss, cost, claims, causes of action, suits, damages, liability, expenses and costs, including reasonable attorney's fees, arising from or out of any violation or infringement (or claimed violation or infringement) by Exhibitor, Exhibitor's agents or employees of any patent, copyright or trade secrets or privileges.

- **Display Dismantling:** The following rules apply to all display dismantling activities.
  - After the exhibit opens at 9:00 AM on Tuesday, March 19, 2019, no part of the exhibitors display may be removed without permission of PEM until the exhibit is officially closed.
  - Dismantling will begin no sooner than 5:01 PM, Thursday, March 21, 2019.
  - All display equipment and material must be packed, ready for shipping by 12:00 Noon, Saturday, March 23, 2019.
  - All material handling forms must show the desired carrier. GES shall have the authority without further clearance from the Exhibitor to change carriers if designated carriers do not pick up shipments on time.

## **REGULATIONS GOVERNING FLAMMABLES, COMPRESSED GASES, AND HAZARDOUS MATERIALS:**

- (a) Exhibitors, service contractors and event promoters must comply with all Federal, State and local fire and building codes that apply to places of public assembly. All curtains, bunting, draping, etc., must be made of flame retardant materials.
- (b) Firefighting and emergency equipment may not be hidden or obstructed, including fire extinguishers, strobes, fire hose cabinets and standpipes. All emergency exits, hallways and aisles leading from the Pennsylvania Convention Center (PCC) must be kept clear and unobstructed. Fire lanes must be maintained at all times on the loading dock.
- (c) FLAMMABLE fluids, substances or materials of any nature may not be used in any booth. All decorative materials must be flame-proofed before being taken into exhibit area. All materials and installation must comply with the requirements of all inspection authorities who have jurisdiction.
- (d) Shredded paper, excelsior, foams and other flammable plastic materials used in packing must be removed from the building. By order of the Fire Marshal, no flammable material is to be scattered in or behind the booth.
- (e) **You may not store empty cartons in or behind your booth back wall.** All empty boxes, crates and cartons used to ship or store equipment or supplies must be placed in storage areas designated by PEM and the Pennsylvania Convention Center (PCC) Event Services Department.
- (f) The City of Philadelphia fire regulations state that only a one-day supply of operational and advertising material, product or literature may be stored within the booth, but not behind your booth back wall.
- (g) The Exhibitor shall not bring upon the premises any exhibit, equipment or vehicle that, in the judgment of Pennsylvania Convention Center (PCC), would be or might be dangerous to persons or property or otherwise incompatible with the structure, systems and furnishings. Hazardous chemicals and materials, including but not limited to, pesticides, herbicides, poisons, flammable and combustible liquids, hazardous gases, pressure cylinders and tanks, and hazardous chemicals (including oxidizers) are prohibited inside the Pennsylvania Convention Center (PCC).
- (h) When designing your demonstrations and displays, please note that the following devices require pre-approval by PCC:
  1. Lasers - All Exhibitors planning to demonstrate or display lasers should be familiar with the contents of the American National Standard Z136.1, the Safe Use of Lasers. Particular attention should be focused on section 4.5.1 relating to laser demonstrations and displays. Any potentially dangerous laser beams must be enclosed or otherwise made inaccessible to visitors. All laser beams must terminate in a beam block substantial enough and suitable for the energy and wavelength. Precautions must be taken to minimize all exposure to stray laser beams, spurious reflections, and any intense non-laser light sources (e.g., UV arc lamps, flash lamps, dye fluorescence) that can pose a serious eye hazard.
  2. Heating appliances.
  3. Gasoline, kerosene or other flammable, toxic liquid, solid or gas - a limited supply of these fuels may be stored in the demonstration device, but cannot be stored overnight. All fuel transfers must utilize safety cans during non-exhibit hours.
  4. Compressed gas or compressed liquid cylinders - Excess fuel/cylinders must be properly stored outside. Compressed gas cylinders used in the booth must be securely anchored to prevent toppling. It is the exhibitors' responsibility to ensure that all compressed gas cylinders are properly secured at all times. If they are not properly secured, PEM will have them secured and the exhibitor will be charged accordingly. Regulations governing the use of flammables, compressed gases, and hazardous materials are included in the PCC Exhibitor Policies. Any chemical, substance or material deemed hazardous by O.S.H.A. requires preapproval and must be accompanied with the appropriate M.S.D.S. The PCC Fire Safety Office will need copies of the M.S.D.S. before the materials arrive. Two copies should be available, one with the Exhibiting Company and one on file with PEM.
- (i) All L.P. Gases are fire-hazardous and prohibited in PCC. Compressed inert gases may be used provided the



vessels are stored in a safe manner. Demonstrations involving inert gases must comply with all Federal and local regulations. Balloons of any kind are strictly prohibited.

- (j) The Exhibitor is responsible for removal of hazardous waste and must comply with all applicable Federal, State and local regulations. Hazardous waste includes materials that are ignitable, corrosive, reactive, toxic or biohazards (as defined under 40 CFR 261 subpart C and D). If materials are questionable, contact the PCC Event Coordination. Costs or applicable administrative expenses incurred by PCC for the removal of hazardous waste left in or about will be assessed to the Exhibitor.
- (k) Exhibitors should be aware that a Fire Safety Officer (FSO) will conduct inspections of all exhibits. Any exhibits judged to be unsafe, for any reason, will be summarily shut down until sufficient corrective modifications have been made. However, acceptance of the exhibit by the FSO does not constitute a guarantee that the exhibit meets all safety standards or is safe under all conditions.
- (l) Exhibitors must inform the PEM at the time of booking space if the exhibit has a ceiling.
- (m) All exhibits must comply with the Americans with Disabilities Act. For more information on compliance, contact PCC Event Services Department.
- (n) Nothing can block AED boxes and /or fire hose cabinets.
- (o) All exhibitors should review the PCC FAQs-Exhibitors-Revised, PCC Safety-Guidelines and PCC16 WorkRules from the PCC that are posted on our website.

## Seminar Rooms (20' x 20' Units)

**Option 1- Without Ceiling (\$7,000/unit):** This room is constructed of sound-absorbing cloth panels and will include the following: exposition-color carpeting, 2 draped tables, 6 side chairs, 2 wastebaskets, and 2 lockable doors. Furniture and additional items can be rented from GES.

**Option 2- With Ceiling (\$8,500/unit):** This room is constructed of sound-absorbing cloth panels and will include the following: exposition-color carpeting, 2 draped tables, 6 side chairs, 2 wastebaskets, 2 lockable doors, ceiling, lighting, air conditioning, and a graphic header. Furniture and additional items for the room can be rented from GES.

Electrical service is a separate cost and must be ordered through PCC using their form which is located on the exhibitor services section of the website. The Exhibitor Service Manual will be available online in late October. Hanging Banners are permitted over Seminar Rooms. See Page 5 for more information.

**Please note all seminar rooms will be available by 8AM on Saturday, March 16, 2019.**

## Additional Details for Booth Configurations

The following information is based on material endorsed by IAEE.

**Material in this section has been reproduced from above endorsement, or modified in parts to present exhibiting rules and regulations of The Pittsburgh Conference.**

The tenet on which the Exposition is based can be summed up as follows: "*All exhibitors are equal regardless of size, and should be given an equal opportunity, within reason, to present their product in the most effective manner to the audience.*"

PEM establishes rules and guidelines to make this possible while allowing the greatest flexibility within each exhibit. You are our customers; we want you to be successful.

The exhibitor's responsibility can be summed up far more simply: "*Be a respectful neighbor.*"

With the above thoughts in mind, please review the rules and regulations outlined on the following pages. Each section begins with a list of restrictions and is then followed by any explanation of the *intent* of the restrictions. By recognizing the *intent* you can be reasonably sure you will always be "a respectful neighbor."



# STANDARD BOOTH

DEFINITION: A single 10' x 10' booth or two 10' x 10' booths in a straight line.

## Restrictions:

- The maximum height for all materials shall be 8' 3" (2.51 m).
- Booths that border another exhibitor must conform to the following height restrictions. **Any display materials** (including but not limited to booth structure, product, instruments, foliage, book racks, and related items) **that exceed a total height of 4' (1.22 m) must be set back 5' (1.52 m) from any aisle or be at least 9' (2.74 m) from any neighboring booth.** The 4' limit is the total height of items on display plus any surface on which they sit.
- In the case of a corner booth, display materials that exceed 4' in height may extend to the front of the booth provided they are within 1' of the aisle adjacent to the side of the booth and do not exceed 8' 3" in height. However, solid walls or displays that substantially block the line-of-sight are not permitted in 10' x 10' corner booths.
- In a 10' x 20' booth, display materials that exceed 4' in height may extend to the aisle provided they are set back at least 9' from any neighboring exhibit and do not exceed 8' 3" in height.

- Canopies are not permitted in standard booths.
- Any portion of the exhibit which borders another exhibitor's booth must have the back side of that portion finished and free of any identification signs or other copy that would detract from the adjoining exhibit. Identification signs and other copy are not permitted on the back and/or side of structures that are within 9' of and face an adjoining exhibit.

## Intent:

- Every exhibitor is entitled to a reasonable line of sight from the aisle regardless of the size of the exhibitor's booth. The restriction of display materials over 4' in height to the back of the booth is intended to accomplish this aim.
- Signs are banned from the back and/ or sides of booths which adjoin another exhibit and from the back and/or sides of structures (i.e., panels, towers, etc.) that are within 9' of and face an adjoining exhibit to prevent confusion over the location of the exhibitor's booth.

(Metric Conversions on Page 15)

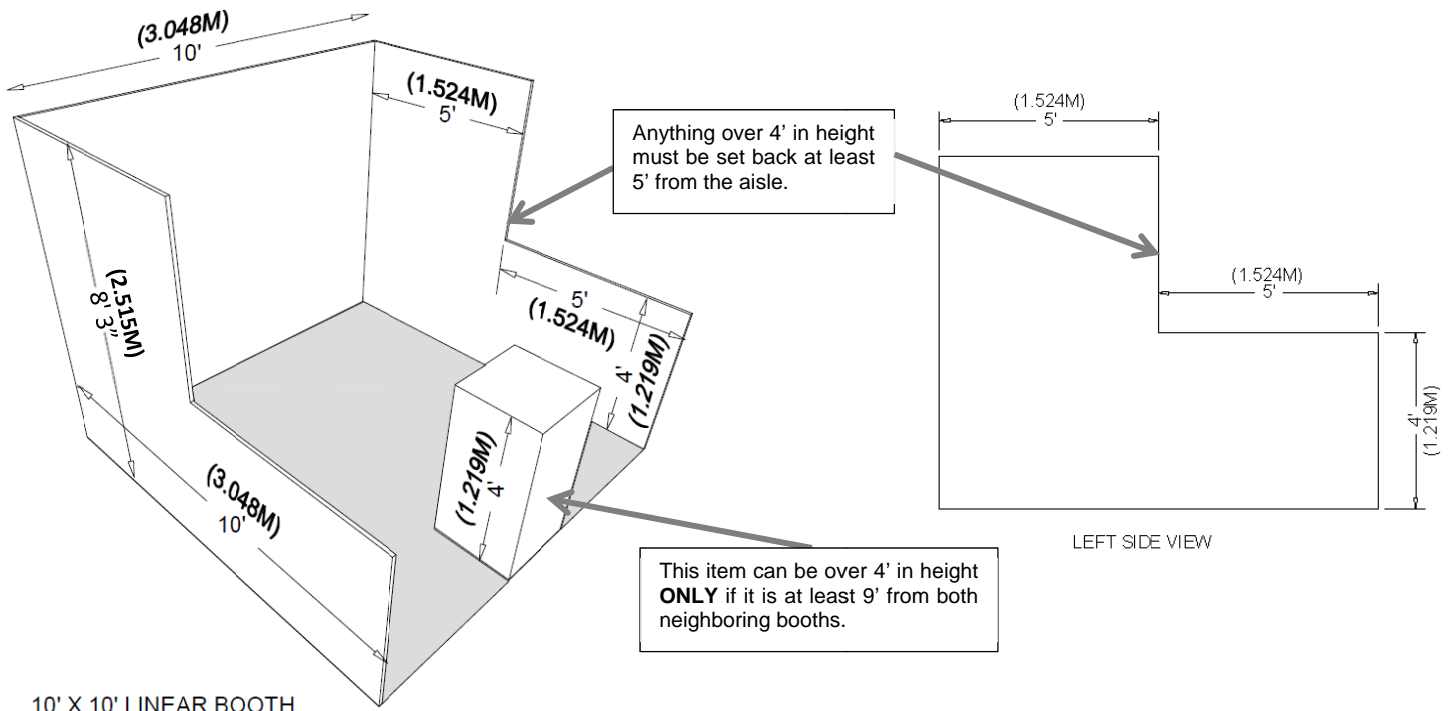

**Note:** Although the dimensions of the **booth space** are 10' x 10', **exhibit structures** must be limited to 10' x 9.5' to allow sufficient **clearance** on the rear of the booth for back drape and utility service.

# MULTIPLE STANDARD BOOTH

DEFINITION: Three or more Standard (10' x 10') Booths in a straight line.

**Restrictions:**

- The maximum height for all materials shall be 8' 3" (2.51 m).
- Booths that border another exhibitor must conform to the following height restrictions. **Any display materials** (including but not limited to booth structure, product, instruments, foliage, book racks, and related items) **that exceed a total height of 4' (1.22 m) must be set back 5' (1.52 m) from any aisle or be at least 9' (2.74 m) from any neighboring booth.** The 4' limit is the total height of items on display plus any surface upon which they sit.
- Any portion of an exhibit which borders another exhibitor's booth must have the back side of that portion finished and must not carry any identification signs or other copy that would detract from the adjoining exhibit. Identification signs and other copy are not permitted on the back and/or sides of structures which are within 9' of and face an adjoining exhibit.

• Canopies are not permitted in multiple standard booths.

**Intent:**

- Every exhibitor is entitled to a reasonable line of sight from the aisle regardless of the size of the exhibitor's booth. The restrictions of display material of over 4' in height to the back 5' of the end booths or the center section or middle booths, more than 9' from neighboring booths is intended to accomplish this aim.
- Signs are banned from the back and/or sides of booths which adjoin another exhibit (i.e., panels, towers, etc.) which are within 9' of and face an adjoining exhibit to prevent confusion over the location of the exhibitor's booth.

**(Metric Conversions on Page 15)**

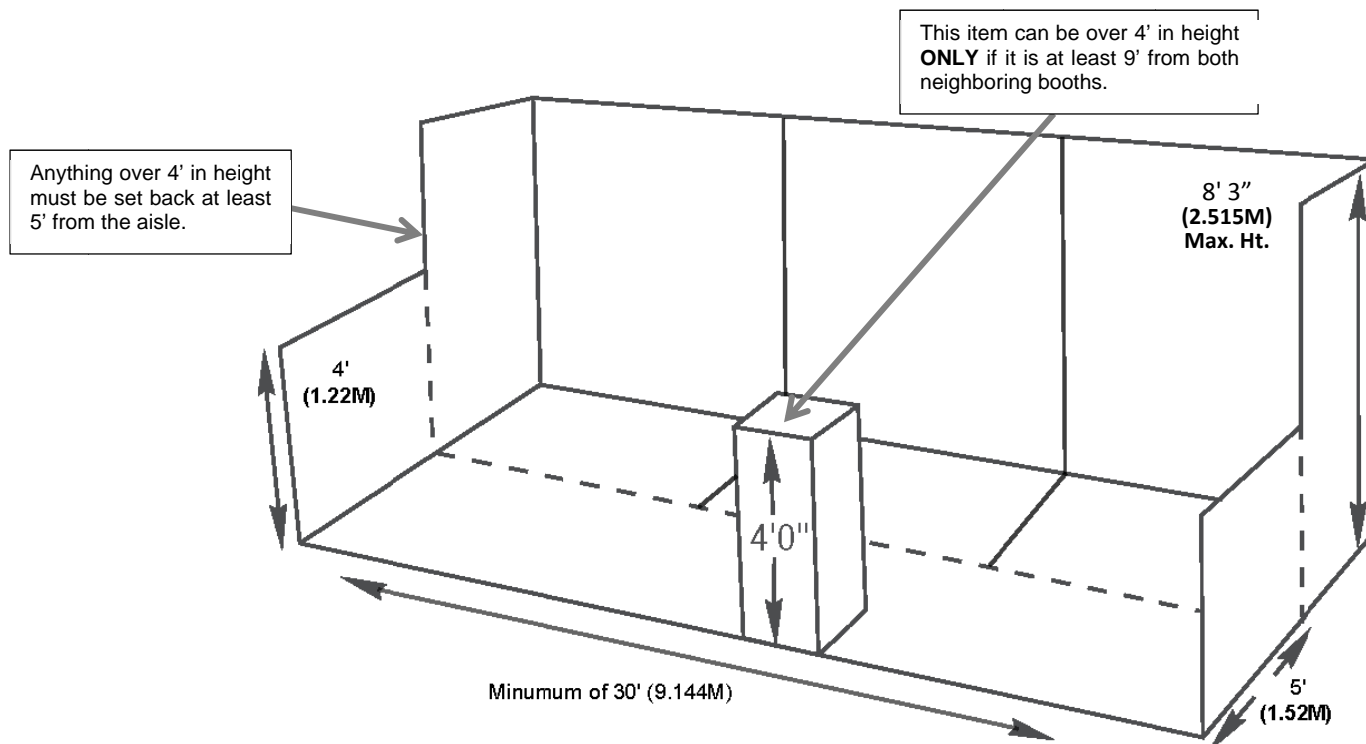

**Note:** Although the dimensions of the **booth space** are 10' x 10', **exhibit structures** must be limited to 10' x 9.5' to allow sufficient **clearance** on the rear of the booth for back drape and utility service.

# CROSS AISLE BOOTH

**DEFINITION:** A set of booths which face one another across an aisle. The minimum size for a Cross Aisle Booth is a set of 10' x 20' Booths.

**Restrictions:**

- The maximum height for all materials shall be 8' 3" (2.51 m).
- Cross aisle booths are not permitted to cross center aisles.
- Booths that border another exhibitor must conform to the following height restrictions. **Any display materials** (including but not limited to booth structure, product, instruments, foliage, book racks, and related items) **that exceed a total height of 4' (1.22 m) must be set back 5' (1.52 m) from any aisle or be at least 9' (2.74 m) from any neighboring booth.** The 4' limit is the total height of items on display plus any surface upon which they sit.
- In the case of a corner cross aisle booth, the height of display materials may exceed 4' within 1' of the aisle adjacent to the side of the booth. However, solid walls or displays that substantially block the line-of-sight are not permitted in corner booths.
- Canopies are not permitted in cross aisle booths.
- **In a cross-aisle configuration, the aisle is not booth space.** Nothing may be placed in the aisle except

carpeting and hanging banners: hanging banners over the aisle may not be lower than 15' from the floor. The aisle must be kept clear of all other display materials (including but not limited to booth structure, product, related items, exhibitor personnel, and signs).

- **During set up, the aisles in a cross aisle booth cannot be blocked to the fork-lift drivers.**
- Exhibitors are responsible for cleaning any exhibitor owned or rented carpet that occupies the aisle space.

**Intent:**

- Every exhibitor is entitled to a reasonable line of sight from the aisle regardless of the size of the exhibitor's booth. The restrictions of display material of over 4' in height to the back 5' of the end booths is intended to accomplish this aim.
- Signs are banned from the back and/or sides of booths which adjoin another exhibit (i.e., panels, towers, etc.) which are within 9' of and face an adjoining exhibit to prevent confusion over the location of the exhibitor's booth.

**(Metric Conversions on Page 15)**

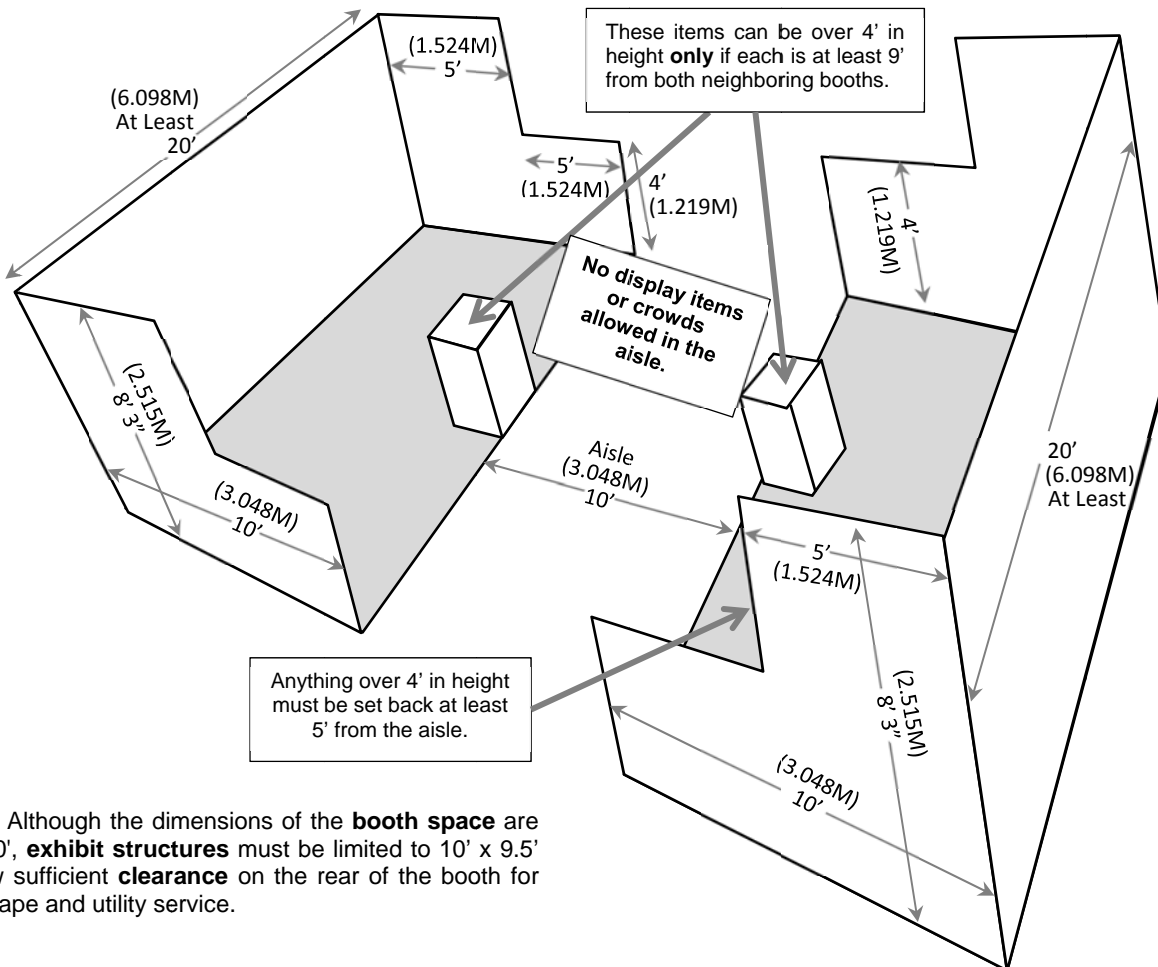

**Note:** Although the dimensions of the **booth space** are 10' x 10', **exhibit structures** must be limited to 10' x 9.5' to allow sufficient **clearance** on the rear of the booth for back drape and utility service.



# PENINSULA BOOTH

**DEFINITION:** A set of back-to-back booths with aisles on three sides. The minimum size for a Peninsula Booth is a set of 10' x 20' Booths.

**Restrictions:**

- Detailed plans of the booth **MUST** be submitted to PEM by Monday, January 21, 2019 for approval.
- The maximum height for all materials shall be 20' (6.10 m) provided exhibitors adhere to the restrictions on the height of display materials near a neighbor's exhibit.
- Booths that border another exhibitor must conform to the following height restrictions. **Any display materials** (including but not limited to booth structure, product, instruments, foliage, book racks, and related items) **that exceed a total height of 4' (1.22 m) must be set back 5' (1.52 m) from any aisle or be at least 9' (2.74 m) from any neighboring booth.** The 4' limit is the total height of items on display plus any surface upon which they sit.

- Any portion of an exhibit which borders another exhibitor's booth must have the back side of that portion finished and must not carry any identification signs or other copy that would detract from the adjoining exhibit. Identification signs and other copy are not permitted on the back and/or sides of structures which are within 9' of and face an adjoining exhibit.

**Intent:**

- Exhibitors adjoining a peninsula display are entitled to the same reasonable line of sight from the aisle as they would expect if they were next to a Standard Booth.
- Signs are banned from the back and/or sides of booths which adjoin another exhibit (i.e., panels, towers, canopies, etc.) which are within 9' of and face an adjoining exhibit to prevent confusion over the location of the exhibitor's booth.

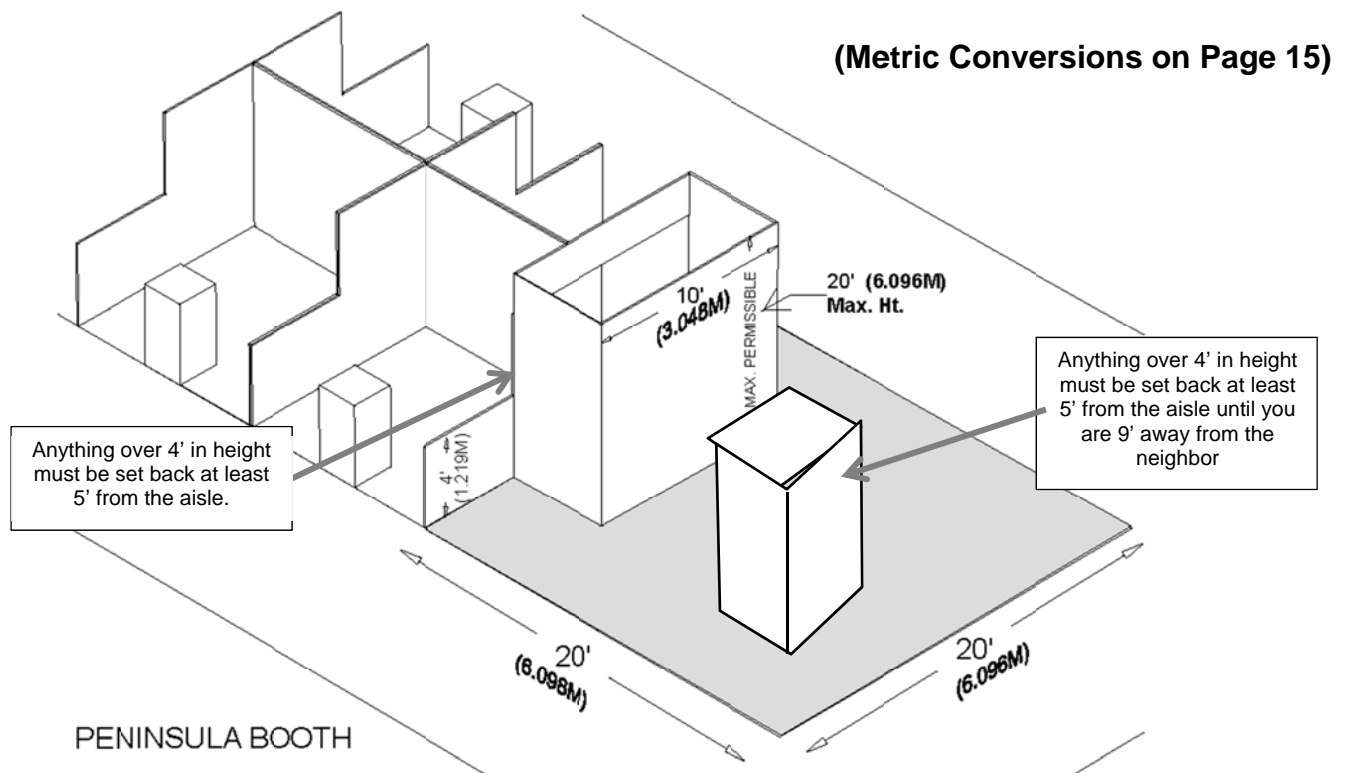

**Note:** Although the dimensions of the **booth space** are 10' x 10', **exhibit structures** must be limited to 10' x 9.5' to allow sufficient **clearance** on the rear of the booth for back drape and utility service.

# ISLAND BOOTH – INCLUDING DOUBLE-DECKER BOOTHS

**DEFINITION:** An Island Booth is a contiguous block of space that has a total area of at least 1,500 square feet with aisles on four sides and at least one interior cross aisle. An Island Booth may also have one or more 10' x 10' double-decker booths.

**Restrictions:**

- Detailed plans of the booth **MUST** be submitted to PEM by Monday, January 21, 2019 for approval.
- All display material (including but not limited to booth structure, product, instruments, foliage, book racks and related items) is restricted to 20' in height. Because an island is automatically separated by the width of an aisle from all neighboring exhibits, **full use of the floor space to the maximum height is permitted; however, solid walls in an island configuration are prohibited. A sufficient “see-through or walk-through” area must be visible so as not to block the view of adjacent exhibit booths.**
- The interior cross aisle within the island booth can be used as part of the exposition area.
- To assure proper and appropriate placement on the floor plan, PEM **MUST** be notified prior to the booth space assignment of any solid structure on any side of the Island Booth, such as a wall or a built in storage unit.

**Intent:**

- Exhibitors next to an island display are entitled to the same reasonable line of sight from the aisle as they would expect if they were near a Standard Booth.
- Since an island display is surrounded by aisles, the only restriction on signs on the back and/or sides is the 20' height limit.

**DOUBLE DECKER BOOTHS:**

- Three copies of the detailed plans of the structure for Double Decker Booth(s) must be submitted to PEM by Monday, January 21, 2019 for approval.
- All double-decker booths must adhere to the 20' height maximum, which runs from the ground floor to the top of the upper level booth. This includes persons, equipment, and signage. Access to the upper level booth(s) must be included in the floor space of the ground level booths.
- Contact the PCC for their **POLICIES & PROCEDURES** regarding DOUBLE DECKERS.

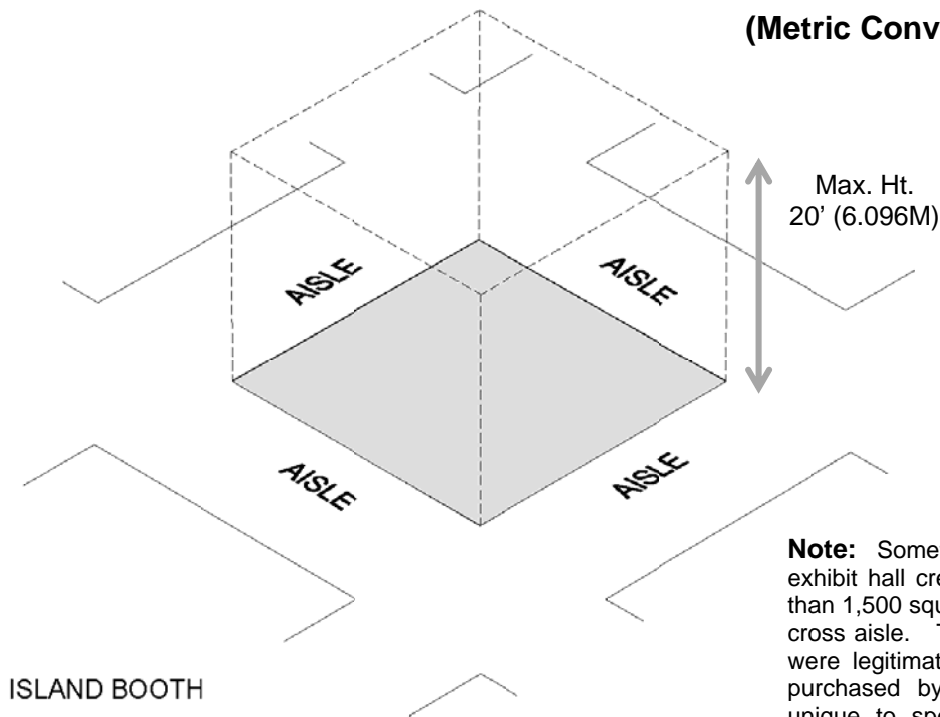

**Note:** Sometimes the physical lay-out of a particular exhibit hall creates small “islands” which are smaller than 1,500 square feet and/or do not contain an interior cross aisle. These “islands” can be treated as if they were legitimate island booths if the entire “island” is purchased by one exhibitor. These “islands” are unique to specific exhibit halls and their existence cannot be guaranteed.

# DEMONSTRATIONS

### Restrictions:

- Demonstrations are not permitted in any aisles of the exposition floor. The exhibitor must design sufficient area into the booth space to absorb any crowds. PEM will restrict or eliminate any demonstrations that interfere with normal traffic flow or that attract crowds which overflow into aisles or neighboring exhibits. These restrictions are applicable to all booth configurations, including Cross Aisle Booths.
- The volume of live or recorded audio demonstrations shall be no louder than 85 decibels at the booth line. PEM will restrict or eliminate any demonstrations which exceed this limit. PEM also reserves the right to restrict or eliminate any demonstration determined to be interfering with neighboring displays, no matter the volume.
- Aisles are not booth space and must be kept clear of all display material, exhibitor personnel, canopies and signs.

### Intent

- The aisles are to remain open as public space. Therefore, each exhibitor has the responsibility to assure proper flow of traffic through the entire exhibit. Large crowds gathering to watch a demonstration, and thereby interfering with traffic flow and crowding neighboring booths, are an infringement on the rights of other exhibitors. **Aisles must not be obstructed at any time.**
- Excessively loud audio displays interfere with the ability of neighboring exhibitors to communicate with their customers.

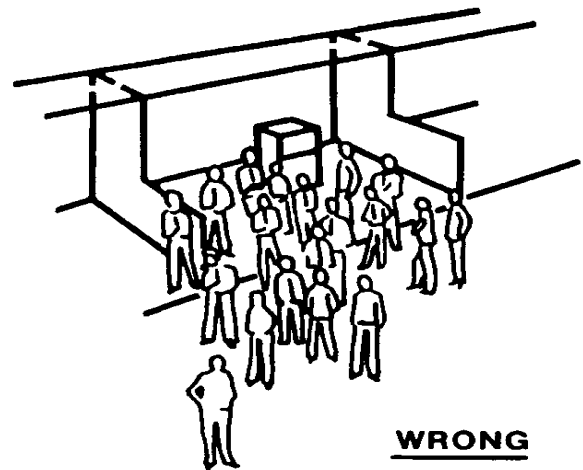
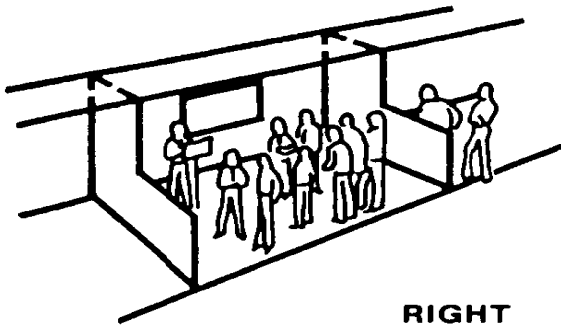

Conversion Chart			
Feet	Meters	Feet	Meters
0.5'	0.15 m	8'	2.44 m
1'	0.30 m	8' 3"	2.51 m
4'	1.22 m	9'	2.74 m
4' 6" (4.5)	1.37 m	9.5'	2.90 m
5'	1.52 m	10'	3.05 m
		20'	6.10 m

**2019 BOOTH SPACE AGREEMENT—TERMS AND CONDITIONS**

1. **DEFINITIONS.** The following terms shall have the meanings given below:
  - i. Agreement shall mean the Exhibitor Booth Space Agreement together with (a) these 2019 Booth Space Agreement Terms and Conditions and (b) the 2019 Display Rules and Regulations, all of which together shall form a single integrated contract.
  - ii. Authority - shall mean Philadelphia, a political subdivision of the State of Pennsylvania.
  - iii. Center - those portions of the Pennsylvania Convention Center licensed by the Authority to the Conference.
  - iv. Conference - The Pittsburgh Conference on Analytical Chemistry and Applied Spectroscopy, a Pennsylvania non-profit corporation.
  - v. Conference Week – Sunday, March 17, 2019 through and including Thursday, March 21, 2019.
  - vi. Event - The Pittcon® 2019, exposition of analytical and spectroscopic equipment and materials sponsored by the Conference, scheduled to take place at the Center, Tuesday, March 19 – Thursday, March 21, 2019 during Conference Week.
  - vii. Event Hours - 9:00 AM to 5:00 PM, Tuesday, March 19, 2019 to Thursday, March 21, 2019 inclusive, daily, during Conference Week, subject to change on notice.
  - viii. Exhibitor - the entity, its parent corporation, or any subsidiaries on whose behalf the Agreement was executed.
  - ix. Exposition Chairman - the person so appointed and designated by the Conference.
  - x. Space - the booths and/or seminar rooms assigned to the Exhibitor by the Conference. Seminar rooms are available for rental only to exhibitors renting booth space.
  - xi. Term – Thursday, March 14, 2019 through and including Saturday, March 23, 2019.
  
2. **LICENSE.** Subject to the terms of the Agreement, the Conference licenses and will make available to the Exhibitor at the Center, the Space for the Event, Subject to Exhibitor complying with the terms of the Agreement, the Exhibitor is entitled to and shall be able to enjoy quiet possession and use of the Space without interference by the Conference or any other person. The license hereby granted to Exhibitor is subject to the terms of the Conference's License from the Authority.
  
3. **RESERVATION/CANCELLATION.** **To reserve the Space, orders must be done online and payments must be received by Monday, August 6, 2018 to be included in the first round of assignments. No space will be allocated until payments are made.** If not received by this date, the Conference reserves the right to cancel the Agreement. If Exhibitor's total payment is in excess of \$15,000, total payment must be received by Monday, November 19, 2018 or Exhibitor will be deemed to have canceled the Agreement. **BOTH THE EXHIBITOR AND THE CONFERENCE SPECIFICALLY RECOGNIZE AND ACKNOWLEDGE THAT THE CONFERENCE WILL SUSTAIN CERTAIN LOSSES IF THE EXHIBITOR CANCELS THE AGREEMENT AFTER ITS EXECUTION. EVEN THOUGH THE CONFERENCE WILL EXERCISE ITS BEST EFFORTS TO RESELL EXHIBITOR'S SPACE, THE PARTIES AGREE THAT THE CONFERENCE WILL INCUR SUBSTANTIAL LOSSES THAT CANNOT BE PRECISELY DETERMINED DUE TO THE DIFFICULTY IF NOT IMPOSSIBILITY OF DETERMINING SUCH LOSSES. ACCORDINGLY, EXHIBITOR AGREES TO THE REFUND POLICY SET FORTH ON THE 2019 BOOTH SPACE AGREEMENT.**
  
4. **CONDITION OF CENTER.** Exhibitor understands and agrees that the Conference has only license to use the Center. The Conference is not in any way responsible for the condition or maintenance of the Center. Exhibitor understands and agrees that all of the Exhibitor's personal property of every kind or description which may at any time be in the Center shall be at the Exhibitor's sole risk, or the risk of those claiming under Exhibitor. The Conference and the Authority shall not be liable for any damage to Exhibitor's property or loss suffered by any cause whatsoever including but not limited to water from any source whatsoever or from the bursting, overflowing or leaking of sewers or steam pipes or from heating or plumbing fixtures or from electrical wires or from gas or odors or caused in any other manner whatsoever.
  
5. **CANCELLATION OF EVENT.** Subject only to the conditions for refund set forth in the Agreement, the Conference shall not be liable in any way for any loss, damage or injury resulting from the cancellation of Event or from temporary or permanent closing for any reason of all or any portion of the Center, unless such cancellation is caused by the willful act of the Conference. The Conference reserves the right to change the location of the Event to other localities or premises. In such event, reasonable prior written notice will be given to Exhibitor. If reasonable prior written notice is given to Exhibitor, Exhibitor waives its right to all damages, expenses, losses or claims of any nature arising out of such change of location.
  
6. **USE OF SPACE.** During the Event, Exhibitor shall use the Space only for the exhibit or display of equipment and/or materials manufactured, licensed, distributed and/or sold by Exhibitor. **Exhibitor shall not sublet or share the space with any other person or party, except with the prior written consent of the Conference. In no event shall Exhibitor conduct exhibitions, seminars or distribute literature either outside the Center or in any non-rented space within the Center at any time during Conference Week. No exhibitor-sponsored functions should be held outside of the leased exposition space during exposition hours without the written permission of the Pittsburgh Conference. Solicitation or advertisement of any type in or outside of the Center (outside of the exhibitor's rented space) by either exhibitor or exhibitor's contractor(s) is strictly prohibited with the exception of approved Pittcon Promotional Opportunities.** If the Exhibitor violates this agreement, the Conference may, at its option, remove from the Center Exhibitor's exhibit, including all equipment and/ or materials belonging to Exhibitor. Exhibitor shall pay the reasonable costs of removal without liability on the part of the Conference for any damage, loss or expense of any sort



whatsoever.

7. **PERMITS.** The Exhibitor at Exhibitor's sole cost and expense shall obtain all permits required to be obtained from public authorities in connection with the exhibit or other activities of the Exhibitor. The Exhibitor shall duly and punctually observe and comply with all currently effective laws, rules and requirements, orders, directions, ordinances, and regulations of: **(a)** the United States of America, the State of Pennsylvania, the City of Philadelphia and the Authority; **(b)** any department bureau, or agency thereof; **(c)** the Board of Fire Underwriters; **(d)** any other board or organization exercising similar functions or powers concerning the exhibit or the activities of the Exhibitor; or **(e)** any union contracts governing the performance of services with respect to the Center. Exhibitor shall also comply with all requests of the Authority and the Conference with respect to the installation, conduct and disassembly of its exhibit. It is the responsibility of the exhibitor to notify the appropriate state agency when NRC-governed radiation sources are being transported across state borders.
8. **NO CONFERENCE ENDORSEMENT.** The Exhibitor shall not in any way represent that any equipment or material is endorsed or approved in any way by the Conference. Exhibitor shall not use the Conference letterhead, seal or any other trademark or service mark of the Conference in any way for advertising or corporate use, or in any other fashion whatsoever, except with the prior written consent of the Conference.
9. **ASSIGNMENT OF SPACE.** The Conference reserves the right to assign the Space and to regulate the use of the Space or the design and appearance of any booth or seminar room. This assignment designation and regulation shall be at the sole discretion of the Conference.
10. **PROHIBITED CONDUCT.**
  - A. The following practices are not permitted:
    1. Distribution of promotional material, samples, catalogs, pamphlets, or advertising, outside of the Exhibitor's Booth Space with the exception of those materials included in the purchase of approved official Pittcon Promotional Opportunities. All Materials for distribution via Promotional Opportunities must be pre-approved by Pittcon marketing personnel;
    2. Use of disruptive audio equipment;
    3. Use of "golf carts" or other vehicles to transport attendees from booths to seminar rooms;
    4. Use of noisy electrical or mechanical equipment;
    5. Wearing of unofficial badges, company name plates, etc. except in addition to official Event badge;
    6. Entry into another Exhibitor's booth without permission of that Exhibitor;
    7. Photographing or examining another Exhibitor's booth without permission of that Exhibitor;
    8. Use of balloons;
    9. Demonstrations which create an interference with neighboring exhibits or with the normal traffic flow in the aisles;
    10. Demonstrations or activities which create a fire, safety or health hazard or which violate the terms of Paragraph 7 above;
    11. Any action, practice, or activity, which violates any of the Pittcon 2019 Display Rules and Regulations;
    12. The dispensing of popcorn on the exposition floor;
    13. Live animals.
  - B. Any display or conduct by Exhibitor which unnecessarily obstructs neighboring booths or interferes with free passage in the aisles will not be permitted. The Conference reserves the right to force re-arrangement or removal of any exhibit which, in the Exposition Chairman's opinion, does not comply with this requirement or to remove any personnel or exhibit for conduct which violates this requirement.
  - C. Unethical conduct or infraction of rules by the Exhibitor will subject the Exhibitor to dismissal from the Center. This determination shall be at the sole discretion of the Conference. In this event it is agreed that no refund shall be made and further that no demand for redress will be made by the Exhibitor. The Conference agrees to enforce for the benefit of Exhibitor all use and similar restrictions placed upon other exhibitors and shall assign and transfer to Exhibitor all such rights should the Conference fail to enforce them in the event Exhibitor seeks to enforce such rights against any other Exhibitor. Exhibitor agrees to indemnify and hold the Conference harmless with respect to any and all claims, demands, damages, loss or expense, including reasonable attorney's fees, arising or resulting from Exhibitor's enforcement of such claims.
11. **BADGES AND STAFFING OF BOOTH.** All representatives of Exhibitor must prominently wear the official Event badge at all times while in the Center and comply with all other badging and security requirements mandated by the Conference. **During Event Hours, Exhibitor's booth must at all times be staffed by a representative or employee of Exhibitor.** Employees of an Exhibitor Appointed Independent Labor Contractor are not permitted to wear exhibitor badges. Exhibitor may only badge their own employees, representatives of the company and/or distributors. Exhibitors will be held responsible for the behavior of anyone who registers as one of these categories.
12. **INDEMNIFICATION AND HOLD HARMLESS.** Exhibitor covenants and agrees that it will protect, save and keep the Conference and the Authority forever harmless and indemnified against and from: **(i)** any penalty, damage or charges including reasonable attorney's fees imposed for violation of any law or ordinance occasioned by the act or neglect of Exhibitor or those holding under Exhibitor, **(ii)** all claims, loss, liability, judgment, cost, damage or expense including all reasonable attorney's fees arising out of or from any accident or other occurrence causing injury or death to any person or damage to any property on or about the Center occasioned by any act, omission or negligence of Exhibitor, its employees, representatives, agents and those persons attending the Event at the specific request or invitation of Exhibitor, and **(iii)** all claims, losses, liability, judgment, cost, damage or expense including reasonable attorney's fees, arising out of or

occasioned by any failure of Exhibitor in any respect to comply with and perform all the requirements and provisions of this Contract.

13. **EXHIBITOR'S OWN RISK.** Please refer to Item #4 above. Exhibitor agrees to place and maintain at Exhibitor's own expense adequate insurance to cover all personal property placed by Exhibitor in the Center. Exhibitor covenants and agrees to indemnify and hold the Conference and the Authority harmless from any injury to or death of Exhibitor, Exhibitor's agents, employees or those persons attending the Event at the specific request or invitation of Exhibitor resulting from or arising out of Exhibitor's use of the Center except that attributable to the negligence or willful misconduct of the Conference.
14. **PATENT, COPYRIGHT, TRADEMARK OR TRADE SECRET.** Exhibitor agrees to hold the Conference and the Authority, their agents and employees, harmless from all loss, cost claims, causes of action, obligations, suits, damages, liability, expenses and costs including reasonable attorney's fees arising from or out of any violation or infringement (or claimed violation or infringement) by Exhibitor, Exhibitor's agents or employees of any patent, trademark, copyright or trade secret rights or privileges and indemnify the Conference from any third party enforcements of rights resulting from Exhibitor's conduct.
15. **DAMAGE TO CENTER.** The Exhibitor shall be responsible for any and all reasonable costs to be paid to the Authority to restore any damage to the Space or the Center caused by the Exhibitor's personnel and employees. The Exhibitor is also responsible for any damages or expense if, because of the act or neglect of Exhibitor's agents or employees, Exhibitor fails to vacate the Center by 8:00 PM on Saturday, March 23, 2019.
16. **MAILING LIST.** The Exhibitor agrees to use the Conference mailing list **only** for Exhibitor's corporate use.
17. **SECURITY.** The Conference does not warrant nor guarantee the presence of guards at any particular time or place in the Center. The Conference shall have no duty or obligation to safeguard or insure Exhibitor's property or personnel and by its execution of the Agreement, Exhibitor understands and agrees that Exhibitor is solely responsible for protecting and securing its property and personnel. Exhibitor must obtain a blanket rider (portal-to-portal or other "extraterritorial" insurance) to protect its property, personnel and visitors, both during the Event and in transit to and from the Event against loss of any kind including, but not limited to, fire, damage or theft. Neither the Authority's nor the Conference's liability insurance covers Exhibitor's property, personnel or visitors against loss, damage or injury and the Conference is not liable or responsible for any such loss or damage. Small equipment or supplies should be safeguarded against theft before, during and after the Event by tamper-proof attachment displays, locked storage or other appropriate means. Exhibitors are responsible for their own material. If constant surveillance of exhibit equipment or supplies is necessary, Exhibitors must make their own arrangements for security.
18. **INSURANCE.** Each Exhibitor shall provide the Conference with a certificate of insurance evidencing that during the Term, Exhibitor will have in full force and effect a comprehensive general liability insurance policy also containing contractual liability insurance and covering claims of bodily injury, death and property damage arising out of Exhibitor's operations, assumed liability or use of the Space and Center, with a combined single limit of at least \$1,000,000.00. Exhibitor's insurance must provide that it is primary coverage for all risks. If Exhibitor cannot obtain this insurance, Exhibitor must sign and return the "WAIVER AND RELEASE." Exhibitor will not be permitted to enter the Center or use the Space unless the certificate or waiver is delivered to the Conference.
19. **CONTRACTORS.** The Conference will designate various official contractors for such services as installation and dismantling, drayage, decorations and photography. Exhibitor is free to contract with non-official contractors, however, no non-official contractor will be permitted access to the Center or the Space until such non-official contractor has delivered to the Conference a certificate of insurance naming the Conference as additional insured and evidencing that such non-official contractor has in place a comprehensive general liability insurance policy covering claims of bodily injury, death and property damage arising out of the non-official contractor's operations at the Center or in the Space and having a combined single limit of at least \$1,000,000.00. No solicitation of business by any non-official contractor will be permitted in the Center.
20. **MISCELLANEOUS.**
  - A. Agreement shall not become effective until executed for the Conference by the Exposition Chairman and shall be deemed made in the City of Pittsburgh, Pennsylvania. No modifications or amendments to Agreement are binding on the Conference unless specially accepted in writing by the Exposition Chairman. The laws of the State of Pennsylvania shall control the interpretation of the Agreement. The person executing Agreement on behalf of Exhibitor hereby warrants that he/she has authority to do so and that the Exhibitor is bound hereby.
  - B. The Conference reserves the right to reject any Agreement from any Exhibitor who the Conference determines, in its sole and unreviewable discretion, will not be exhibiting equipment or materials relevant to the Event, or who the Conference determines sponsors or produces a trade show or exposition in competition with the Event.